



Application

- Wastewater drainage in factories, construction sites and commercial facilities
- Drainage system in municipal sewage treatment plants
- Drainage station in residential quarters
- Municipal projects
- Methane pools and field irrigation in countryside

Pump

- Max. immersion depth: 5 m
- Max. liquid temperature: +40°C
- Liquid pH value: 5 – 9
- Max. liquid density: 1.2x10³kg/m³

Motor

- Copper winding
- Insulation class: B
- Protection class: IP68

Identification Codes

65 WQ D 15-10-1.1

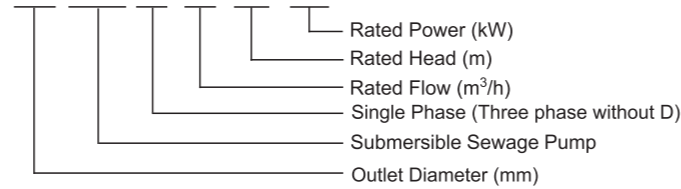

Technical Data

Model	Voltage		Motor Power		Outlet	Guide Rial Fitting	Max flow	Max head	Speed	Impeller passage	N.W	Packing dimension
	V	kW	HP	in								
50WQ10-10-0.75	380	0.75	1	2	50-50	28	13	3000	25	18	500*260*240	
50WQD10-10-0.75	220	0.75	1	2	50-50	28	13	3000	25	19	500*260*240	
50WQ8-16-1.1	380	1.1	1.5	2	50-50	25	19	3000	20	23.5	510*260*240	
50WQD8-16-1.1	220	1.1	1.5	2	50-50	25	19	3000	20	24.5	520*260*240	
65WQ15-10-1.1	380	1.1	1.5	2 1/2	50-65	28	15	3000	25	23.5	510*260*240	
65WQD15-10-1.1	220	1.1	1.5	2 1/2	50-65	28	15	3000	25	24.5	520*260*240	
50WQ8-20-1.5	380	1.5	2	2	50-50	25	22	3000	20	25	520*260*240	
50WQD8-20-1.5	220	1.5	2	2	50-50	25	22	3000	20	26	520*260*240	
65WQ15-15-1.5	380	1.5	2	2 1/2	50-65	35	20	3000	25	25	520*260*240	
65WQD15-15-1.5	220	1.5	2	2 1/2	50-65	35	20	3000	25	26	520*260*240	
50WQ15-20-2.2	380	2.2	3	2	50-50	38	23	3000	25	44	680*260*300	
65WQ25-17-2.2	380	2.2	3	2 1/2	65-65	44	22	3000	25	42	680*260*300	
80WQ40-9-2.2	380	2.2	3	3	65-80	65	16	3000	30	41	710*260*290	
50WQ15-26-3	380	3	4	2	50-50	47	29	3000	25	49	710*260*290	
65WQ25-22-3	380	3	4	2 1/2	65-65	55	26	3000	30	52	710*260*290	
80WQ40-13-3	380	3	4	3	80-80	72	21	3000	30	51	740*240*290	
100WQ60-9-3	380	3	4	4	80-100	88	19	3000	30	53	740*240*290	
65WQ25-28-4	380	4	5.5	2 1/2	65-65	55	32	3000	25	61	770*260*230	
80WQ40-18-4	380	4	5.5	3	80-80	80	24	3000	30	64	800*260*290	
100WQ60-13-4	380	4	5.5	4	80-100	89	24	3000	30	65	800*260*290	
50WQ15-40-5.5	380	5.5	7.5	2	50-50	50	43	3000	25	73	790*290*310	
80WQ30-30-5.5	380	5.5	7.5	3	80-80	47	37	3000	30	73	810*290*320	

Model	Voltage		Motor Power		Outlet	Guide Rial Fitting	Max flow	Max head	Speed	Impeller passage	N.W	Packing dimension
	V	kW	HP	in								
100WQ65-15-5.5	380	5.5	7.5	4	100-100A	108	25	3000	30	79	820*300*350	
100WQ45-22-7.5	380	7.5	10	4	100-100A	90	31	3000	35	115	1000*360*380	
150WQ100-10-7.5	380	7.5	10	6	150-150	140	20	3000	35	115	1010*370*410	
100WQ65-15-5.5(4P)	380	5.5	7.5	4	100-100	145	21	1500	55	126	1030*450*530	
150WQ110-10-5.5(4P)	380	5.5	7.5	6	150-150	200	16	1500	55	153	1030*450*530	
100WQ100-15-7.5(4P)	380	7.5	10	4	100-100	170	21	1500	55	156	1030*450*530	
150WQ150-10-7.5(4P)	380	7.5	10	6	150-150	220	16	1500	75	163	1050*500*600	
100WQ100-25-11(4P)	380	11	15	4	100-100	180	26	1500	50	221	500*600*1050	
150WQ130-15-11(4P)	380	11	15	6	150-150	270	20	1500	50	239	500*600*1180	
200WQ300-7-11(4P)	380	11	15	8	200-200	360	18	1500	65	252	500*600*1180	
100WQ100-30-15(4P)	380	15	20	4	100-100	190	32	1500	50	239	500*600*1180	
150WQ130-20-15(4P)	380	15	20	6	150-150	300	23	1500	50	259	500*600*1180	
200WQ250-11-15(4P)	380	15	20	8	200-200	380	22	1500	65	274	500*600*1180	
150WQ180-20-18.5(4P)	380	18.5	25	6	150-150	300	26	1500	50	300	510*640*1210	
200WQ250-15-18.5(4P)	380	18.5	25	8	200-200	400	25	1500	65	300	510*640*1210	
150WQ180-25-22(4P)	380	22	30	6	150-150	330	28	1500	50	324	510*640*1250	
200WQ300-15-22(4P)	380	22	30	8	200-200	450	28	1500	65	324	510*640*1250	
150WQ180-30-30(4P)	380	30	40	6	150-150	350	38	1500	70	445	630*660*1360	
200WQ250-22-30(4P)	380	30	40	8	200-200	500	34	1500	70	446	660*690*1360	
250WQ600-9-30(4P)	380	30	40	10	250-250	600	28	1500	70	446	660*710*1360	
300WQ800-7-30(4P)	380	30	40	12	300-300	1000	18	1500	80	486	700*750*1450	
150WQ160-45-37(4P)	380	37	50	6	150-150	380	43	1500	70	490	630*660*1360	
200WQ350-25-37(4P)	380	37	50	8	200-200	500	38	1500	70	492	660*690*1360	
250WQ600-12-37(4P)	380	37	50	10	250-250	720	32	1500	70	495	660*710*1360	
300WQ900-8-37(4P)	380	37	50	12	300-300	1200	22	1500	80	535	700*750*1450	
200WQ380-28-45(4P)	380	45	60	8	200-200	800	38	1500	70	545	660*710*1450	
250WQ600-15-45(4P)	380	45	60	10	250-250	600	43	1500	70	545	660*710*1500	
300WQ800-12-45(4P)	380	45	60	12	300-300	1300	25	1500	80	575	700*750*1600	

Materials Table

Item No.	Part Name	Material
01	Handle	Steel
02	Upper cover	Cast iron
03	Capacitor	
04	Thermal protector	
05	Upper bearing seat	Cast iron
06	Bearing	
07	Stator	
08	Rotor	
09	Bearing	
10	Motor body	Cast iron
11	Bearing seat	Cast iron
12	Pump body	Cast iron
13	Impeller	Cast iron
14	Base	Cast iron
15	Cable	
16	Mechanical seal	Sic-Sic/Carbon-Ceramic(<7.5 kW) Sic-Sic/Sic-Sic(>7.5 kW)
17	Oil seal	
18	Hose coupling	Cast iron
19	Terminal box	Cast iron
20	Seal bracket	Cast iron
21	Wiring terminal	

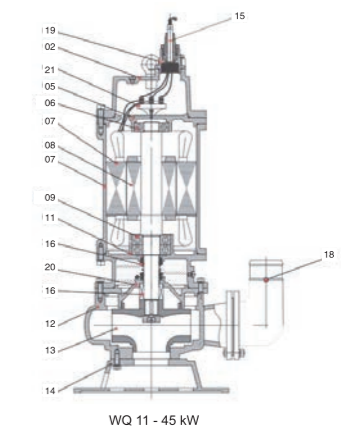
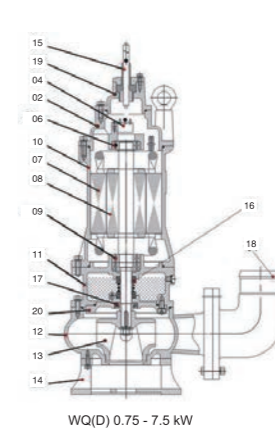

Hydraulic Performance Curves

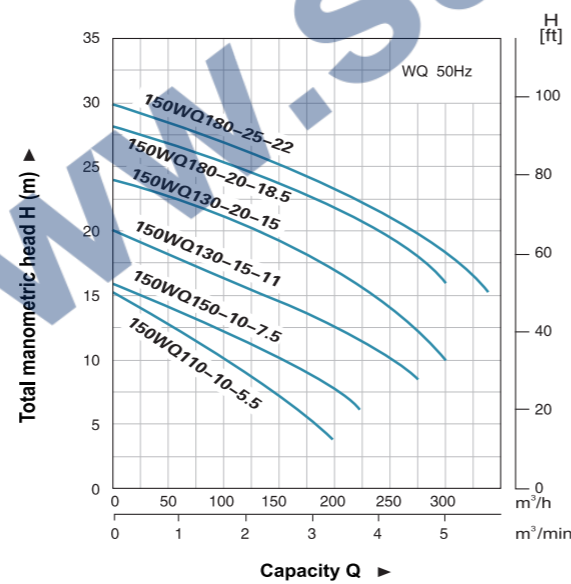
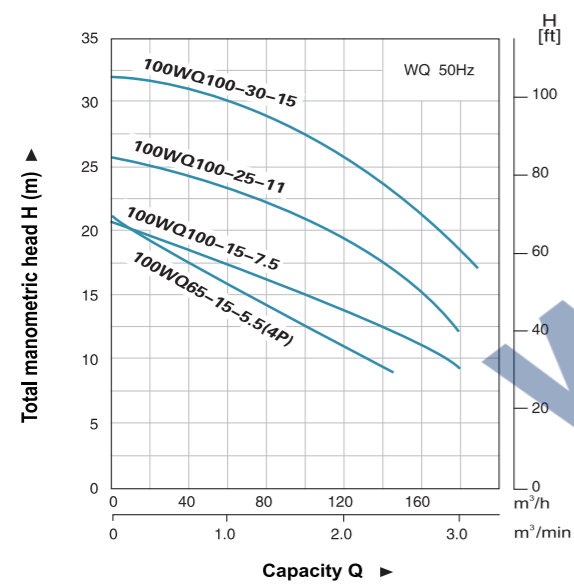
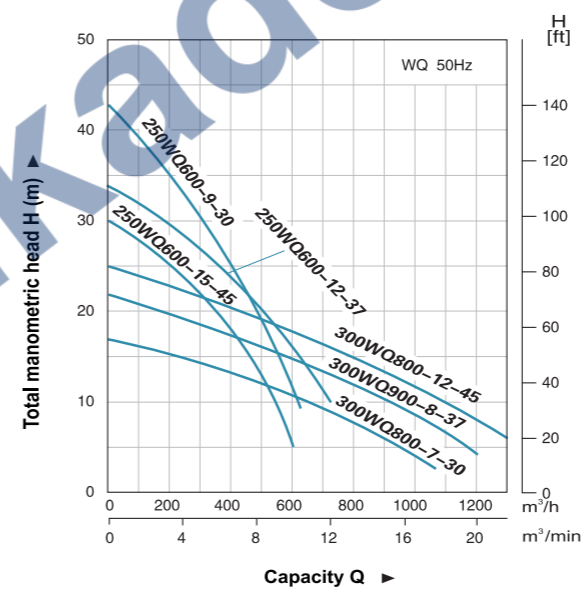
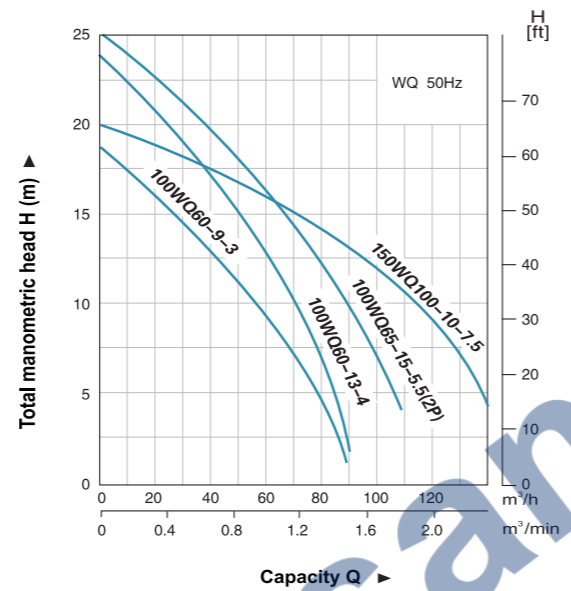
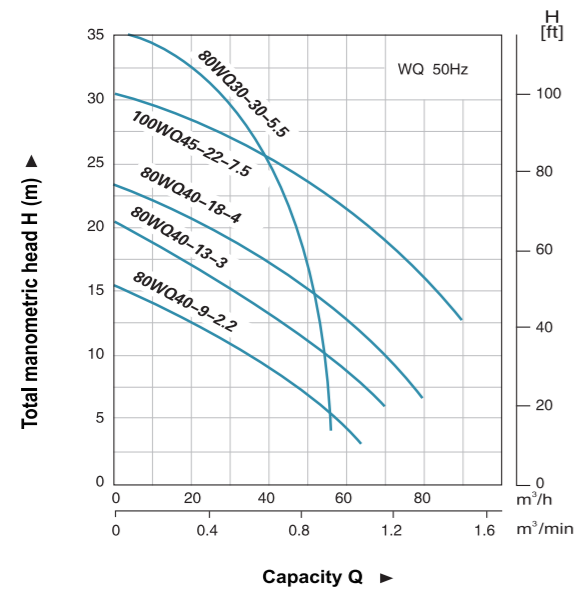
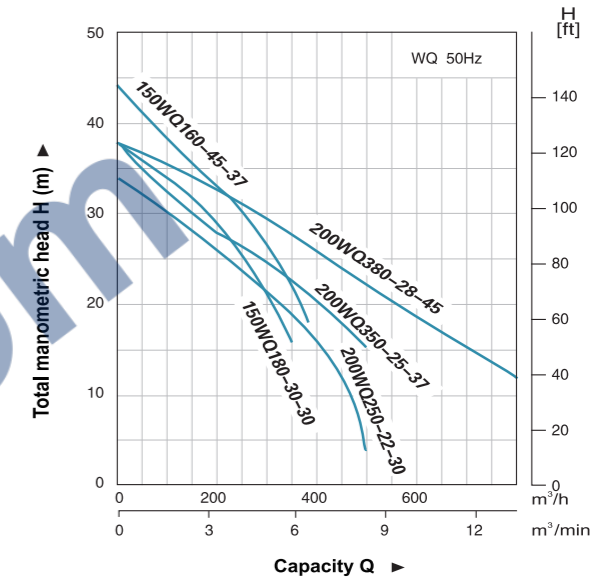
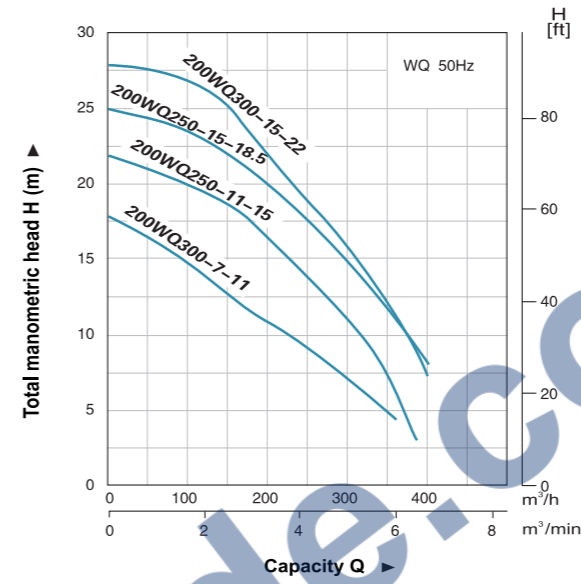
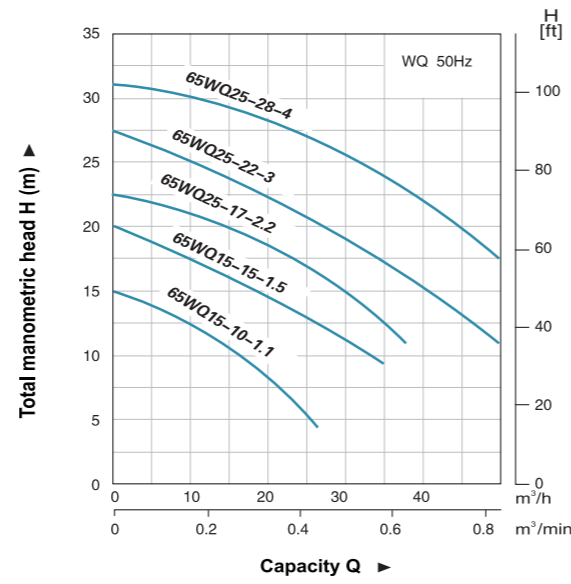
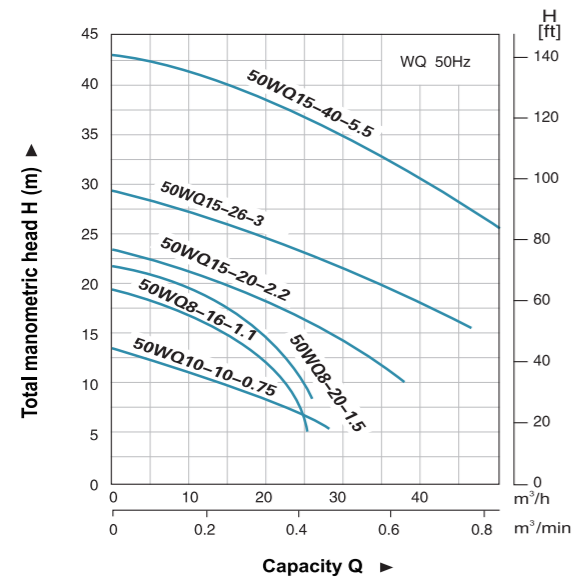

Dimension

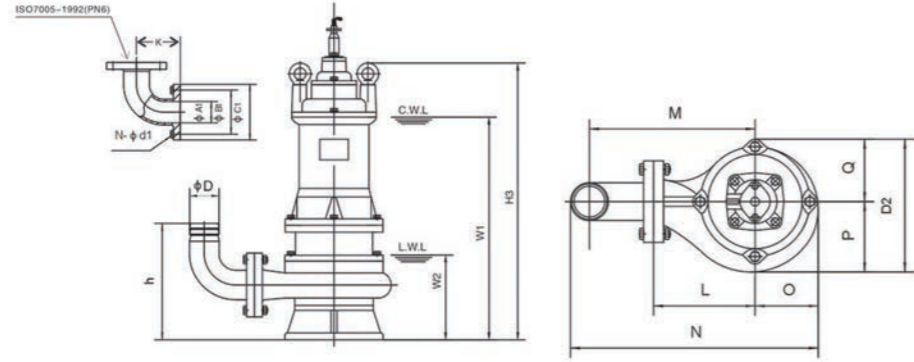

Model	ΦD	ΦA1	ΦB1	ΦC1	n-Φd1	h	W1	W2	H3	K	N	O	P	Q	L	M	D2
50WQ10-10-0.75	50	50	110	140	4-Φ14	204	340	136	450	100	330	95	100	85	140	205	185
50WQD10-10-0.75	50	50	110	140	4-Φ14	204	340	136	450	100	330	95	100	85	140	205	185
50WQ8-16-1.1	50	50	110	140	4-Φ14	202	350	142	460	100	340	90	105	82	145	210	187
50WQD8-16-1.1	50	50	110	140	4-Φ14	202	370	142	480	100	340	90	105	82	145	210	187
65WQ15-10-1.1	65	50	110	140	4-Φ14	212	350	142	460	122	345	90	105	82	145	208	187
65WQD15-10-1.1	65	50	110	140	4-Φ14	212	370	142	480	122	345	90	105	82	145	208	187
50WQ8-20-1.5	50	50	110	140	4-Φ14	202	370	142	480	100	340	90	105	82	145	210	187
50WQD8-20-1.5	50	50	110	140	4-Φ14	202	390	142	500	100	340	90	105	82	145	210	187
65WQ15-15-1.5	65	50	110	140	4-Φ14	212	370	142	480	122	345	90	105	82	145	208	187
65WQD15-15-1.5	65	50	110	140	4-Φ14	212	390	142	500	122	345	90	105	82	145	208	187
50WQ15-20-2.2	50	50	110	140	4-Φ14	213	445	150	550	100	360	105	114	98	165	230	212
65WQ25-17-2.2	65	65	130	160	4-Φ14	223	445	150	550	122	365	105	115	100	165	228	215
80WQ40-9-2.2	80	65	130	160	4-Φ14	251	455	158	560	122	385	105	112	96	160	245	208
50WQ15-26-3	50	50	110	140	4-Φ14	212	464	150	570	100	360	105	115	97	165	230	212
65WQ25-22-3	65	65	130	160	4-Φ14	222	464	150	570	122	365	105	115	98	165	228	213
80WQ40-13-3	80	80	150	190	4-Φ18	262	490	177	595	140	380	105	115	98	155	235	213
100WQ60-9-3	100	80	150	190	4-Φ18	292	490	177	595	150	410	105	115	98	155	255	213
65WQ25-28-4	65	65	130	160	4-Φ14	241	502	170	612	122	390	115	125	110	180	243	235
80WQ40-18-4	80	80	150	190	4-Φ18	272	528	195	640	140	375	105	112	98	150	230	210
100WQ60-13-4	100	80	150	190	4-Φ18	302	528	195	640	150	405	105	112	98	150	250	210
50WQ15-40-5.5	50	50	110	140	4-Φ14	237	523	165	645	100	390	120	125	115	180	245	240
80WQ30-30-5.5	80	80	150	190	4-Φ18	270	540	182	660	140	405	110	115	105	175	255	220
100WQ65-15-5.5	100	100	170	210	4-Φ18	305	555	197	675	150	461	130	140	115	181	281	255
100WQ65-22-7.5	100	100	170	210	4-Φ18	340	660	265	820	150	495	140	150	130	205	305	280
150WQ100-10-7.5	150	150	225	265	8-Φ18	560	670	280	830	230	565	145	160	135	210	345	295

Dimension

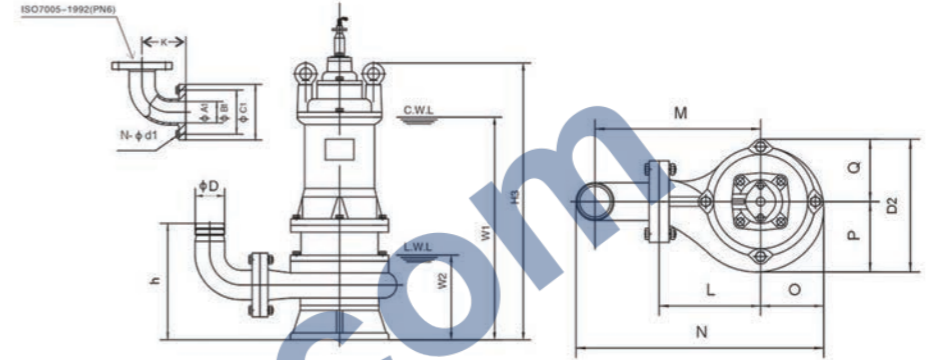

Model	ΦD	ΦA1	ΦB1	ΦC1	n-Φd1	h	W1	W2	H3	K	N	O	P	Q	L	M	D2
100WQ65-15-5.5(4P)	100	100	170	210	4-Φ18	362	677	268	835	150	620	190	200	175	280	380	375
150WQ110-10-5.5(4P)	150	150	225	265	8-Φ18	415	697	288	855	230	680	195	210	170	275	410	380
100WQ100-10-7.5(4P)	100	100	170	210	4-Φ18	382	695	286	853	150	675	205	225	190	320	420	415
150WQ150-10-7.5(4P)	150	150	225	265	8-Φ18	420	708	300	866	230	705	195	216	170	300	345	386
100WQ100-25-11(4P)	100	100	170	210	4-Φ18	370	730	278	980	150	680	210	240	220	320	420	460
150WQ130-15-11(4P)	150	150	225	265	8-Φ18	450	780	331	1020	230	760	200	240	190	350	458	430
200WQ300-7-11(4P)	200	200	280	320	8-Φ18	590	780	327	1020	260	875	205	240	190	370	570	430
100WQ100-30-15(4P)	100	100	170	210	4-Φ18	370	770	278	1010	150	680	210	240	220	320	420	460
150WQ130-20-15(4P)	150	150	225	265	8-Φ18	450	820	331	1060	230	760	200	240	190	350	485	430
200WQ250-11-15(4P)	200	200	280	320	8-Φ18	590	820	327	1060	260	875	205	240	190	370	570	430
150WQ180-20-18.5(4P)	150	150	225	265	8-Φ18	450	885	331	1130	230	760	200	240	190	350	485	430
200WQ250-15-18.5(4P)	200	200	280	320	8-Φ18	590	885	327	1130	260	875	205	240	190	370	570	430
150WQ180-25-22(4P)	150	150	225	265	8-Φ18	450	915	331	1160	230	760	200	240	190	350	485	430
200WQ300-15-22(4P)	200	200	280	320	8-Φ18	590	915	327	1160	260	875	205	240	190	370	570	430
150WQ180-30-30(4P)	150	150	225	265	8-Φ18	463	972	390	1200	230	810	240	270	230	360	495	500
200WQ250-22-30(4P)	200	200	280	320	8-Φ18	593	960	380	1200	260	950	250	310	220	400	600	530
250WQ600-9-30(4P)	250	250	335	375	12-Φ18	665	1020	434	1250	300	1030	260	330	240	410	615	570
300WQ800-7-30(4P)	300	300	395	440	12-Φ18	750	1070	455	1300	350	1040	270	330	240	410	620	570
150WQ160-45-37(4P)	150	150	225	265	28-Φ18	463	972	390	1185	230	810	240	270	230	360	495	500
200WQ350-25-37(4P)	200	200	280	320	8-Φ18	593	960	380	1170	260	950	250	310	220	400	600	530
250WQ600-12-37(4P)	250	250	335	375	12-Φ18	665	1020	434	1230	300	1000	260	330	240	410	615	570
300WQ900-8-37(4P)	300	300	395	440	12-Φ22	750	1070	455	1280	350	1040	270	330	240	410	620	570
200WQ380-28-45(4P)	200	200	280	320	8-Φ18	560	1045	412	1250	260	950	250	310	220	400	600	530
250WQ600-15-45(4P)	250	250	335	375	12-Φ18	665	1065	434	1230	300	1000	260	330	240	410	615	570
300WQ800-12-45(4P)	300	300	395	440	12-Φ22	750	1110	455	1350	350	1040	270	330	240	410	620	570